

# Hot Water Heater

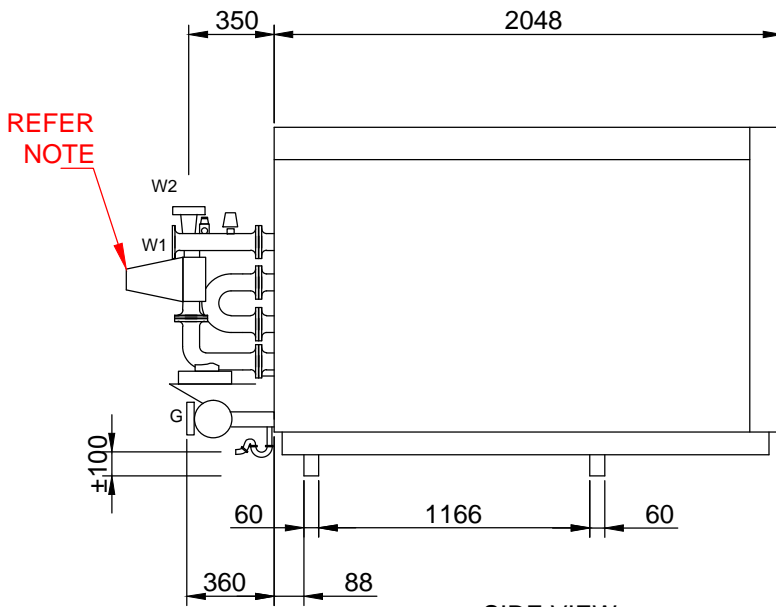

## HIGH EFFICIENCY CONDENSING BOILERS



SIDE VIEW

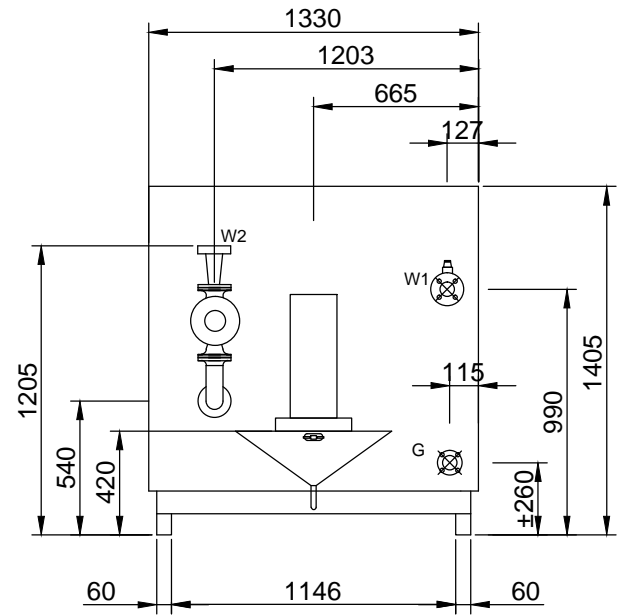

REAR VIEW

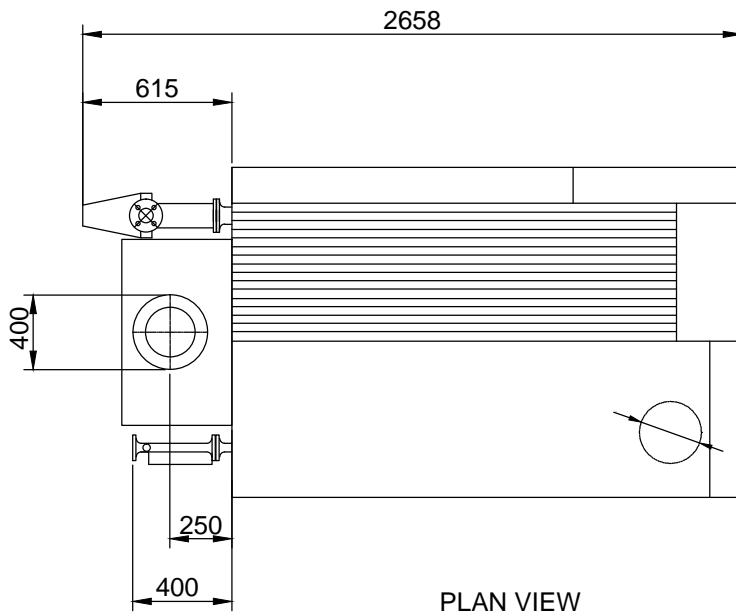

PLAN VIEW

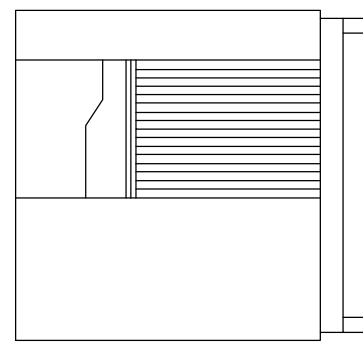

FRONT VIEW

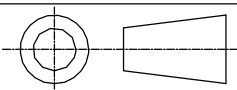

DRAWN TO AS1100:  
DO NOT SCALE:  
DIMENSIONS  
IN MILLIMETERS:



CONSOLIDATED FIRE & STEAM  
32 Research Drive  
CROYDON SOUTH  
Victoria, Australia, 3136  
Ph: +61 (03) 8761 6677  
Web: www.confas.com.au

Notice: These drawings are the property of CF&S Pty. Ltd.  
These drawings and specifications may not be reproduced, copied  
or used as the basis for the manufacture or sale without written  
permission from CF&S Pty. Ltd.



Copyright 2005

**NOTE:**  
**CIRCULATING PUMP**  
**NOT INCLUDED IN**  
**STANDARD SUPPLY.**

TITLE: GENERAL DIMENSIONS  
R3604SB STANDARD BOILER

SIZE:  
**A4**